

Controlmec™ 1ZW

Round front panel sealed solution •
for navigation unit • illumination option



DISTINCTIVE FEATURES

- Round Ø29.5 mm
- h=12.3 mm
- Front panel sealing to IP67
- One piece navigational cap
- Single components or a complete module

SWITCH SPECIFICATIONS : see Multimec™ 5 series.

5G+4x5E TH +1ZW

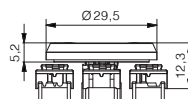

CONTROLMEC 1ZW MODULE



ILLUMINATED MODULE

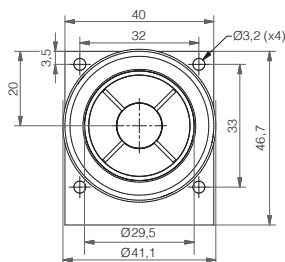
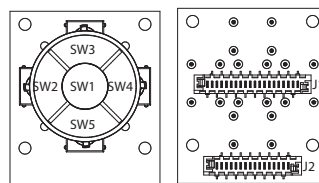
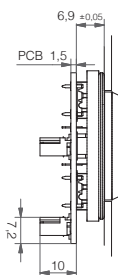

NON-ILLUMINATED MODULE

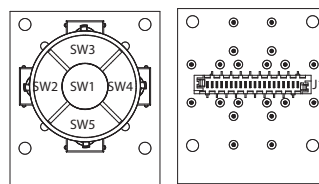
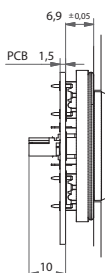

Controlmec™ 1ZW

Round front panel sealed solutions •
for navigation unit • illumination option



CONNECTOR INFORMATION

Connectors on the module are Molex picoflex series 90816-0320 for switches and 90816-0316 for additional LEDs.

We recommend using:

Cable socket: 90327-0320 for switches and 90327-0316 for additional LEDs.



PANEL CUT-OUT

• Controlmec™ : $\varnothing 30,3 \pm 0,1$ mm



PCB LAYOUT

TH

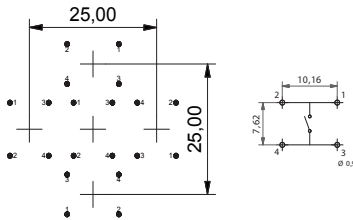

SMD

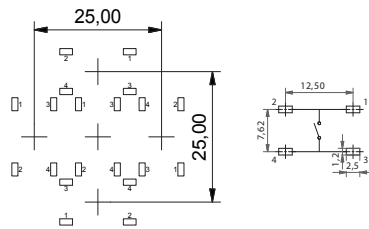

LED placement

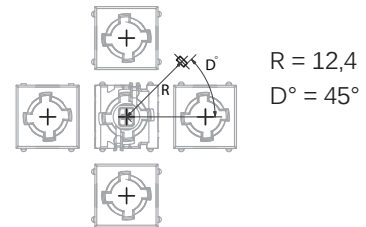

CIRCUIT DIAGRAMS FOR THE MODULE

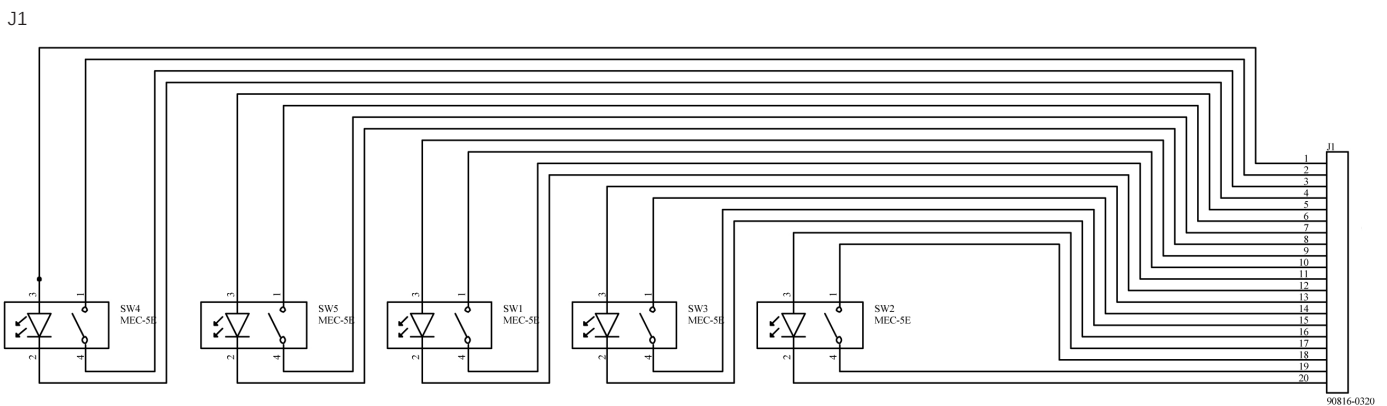

- | | | | |
|-----------------|------------------|------------------|------------------|
| 1 - SW4 ANODE | 6 - SW5 CONTACT | 11 - SW1 CONTACT | 16 - SW3 CATHODE |
| 2 - SW4 CONTACT | 7 - SW5 CONTACT | 12 - SW1 CATHODE | 17 - SW2 ANODE |
| 3 - SW4 CONTACT | 8 - SW5 CATHODE | 13 - SW3 ANODE | 18 - SW2 CONTACT |
| 4 - SW4 CATHODE | 9 - SW1 ANODE | 14 - SW3 CONTACT | 19 - SW2 CONTACT |
| 5 - SW5 ANODE | 10 - SW1 CONTACT | 15 - SW3 CONTACT | 20 - SW2 CATHODE |

J2

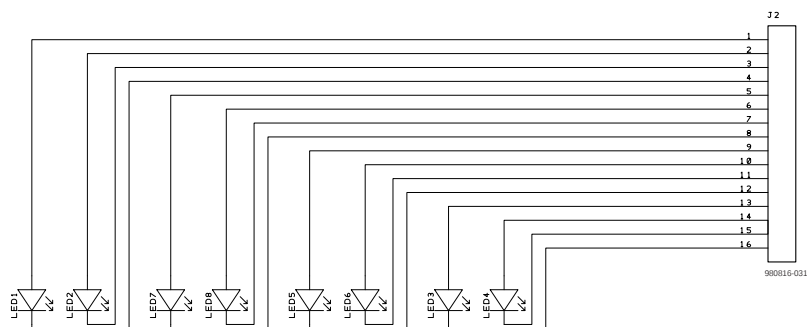

- | |
|-------------------|
| 1 - LED1 ANODE |
| 2 - LED2 ANODE |
| 3 - LED2 CATHODE |
| 4 - LED1 CATHODE |
| 5 - LED7 ANODE |
| 6 - LED8 ANODE |
| 7 - LED8 CATHODE |
| 8 - LED7 ANODE |
| 9 - LED5 ANODE |
| 10 - LED6 ANODE |
| 11 - LED6 CATHODE |
| 12 - LED5 CATHODE |
| 13 - LED3 ANODE |
| 14 - LED4 ANODE |
| 15 - LED4 CATHODE |
| 16 - LED3 CATHODE |

Controlmec™ 1ZW

Round front panel sealed solutions •
for navigation unit • illumination option



BUILD YOUR PART NUMBER

SINGLE PARTS

5G + 4x5E																																																																		
SWITCH	MOUNTING	ACTUATION FORCE	LED*	CAP	COLOR	LEGEND TYPE*	FOR SEALING																																																											
	<table border="0" style="width: 100%;"> <tr> <td style="width: 50%;">TH9 through-hole</td> <td style="width: 50%;"></td> </tr> <tr> <td>SH9 surface mount</td> <td></td> </tr> </table>	TH9 through-hole		SH9 surface mount		<table border="0" style="width: 100%;"> <tr> <td style="width: 50%;">35 3.5N</td> <td style="width: 50%;"></td> </tr> <tr> <td>65 6.5N</td> <td></td> </tr> </table>	35 3.5N		65 6.5N		<table border="0" style="width: 100%;"> <tr> <td style="width: 50%;">02 blue</td> <td style="width: 50%;"></td> </tr> <tr> <td>22 green</td> <td></td> </tr> <tr> <td>29 high intensity green</td> <td></td> </tr> <tr> <td>42 yellow</td> <td></td> </tr> <tr> <td>61 white</td> <td></td> </tr> <tr> <td>82 red</td> <td></td> </tr> <tr> <td>2242 green/yellow</td> <td></td> </tr> <tr> <td>8222 red/green</td> <td></td> </tr> <tr> <td>8242 red/yellow</td> <td></td> </tr> </table>	02 blue		22 green		29 high intensity green		42 yellow		61 white		82 red		2242 green/yellow		8222 red/green		8242 red/yellow		1ZW	<table border="0" style="width: 100%;"> <tr> <td colspan="2" style="text-align: center;">illuminated</td> </tr> <tr> <td style="width: 50%;">16 frosted white</td> <td style="width: 50%;"></td> </tr> <tr> <td colspan="2" style="text-align: center;">non illuminated</td> </tr> <tr> <td style="width: 50%;">02 green</td> <td style="width: 50%;"></td> </tr> <tr> <td>03 grey</td> <td></td> </tr> <tr> <td>04 yellow</td> <td></td> </tr> <tr> <td>06 white</td> <td></td> </tr> <tr> <td>09 black</td> <td></td> </tr> </table>	illuminated		16 frosted white		non illuminated		02 green		03 grey		04 yellow		06 white		09 black		<table border="0" style="width: 100%;"> <tr> <td style="width: 50%;">Blank pad printed</td> <td style="width: 50%;"></td> </tr> <tr> <td>LMH hard paint laser marked</td> <td></td> </tr> </table>	Blank pad printed		LMH hard paint laser marked		<table border="0" style="width: 100%;"> <tr> <td colspan="2" style="text-align: center;">LEGEND*</td> </tr> <tr> <td style="width: 50%;"></td> <td style="width: 50%; text-align: center;">edge</td> </tr> <tr> <td></td> <td style="text-align: center;">136 ▲</td> </tr> <tr> <td></td> <td style="text-align: center;">center</td> </tr> <tr> <td></td> <td style="text-align: center;">118 OK</td> </tr> <tr> <td></td> <td style="text-align: center;">123 ⏻</td> </tr> </table>		LEGEND*			edge		136 ▲		center		118 OK		123 ⏻
TH9 through-hole																																																																		
SH9 surface mount																																																																		
35 3.5N																																																																		
65 6.5N																																																																		
02 blue																																																																		
22 green																																																																		
29 high intensity green																																																																		
42 yellow																																																																		
61 white																																																																		
82 red																																																																		
2242 green/yellow																																																																		
8222 red/green																																																																		
8242 red/yellow																																																																		
illuminated																																																																		
16 frosted white																																																																		
non illuminated																																																																		
02 green																																																																		
03 grey																																																																		
04 yellow																																																																		
06 white																																																																		
09 black																																																																		
Blank pad printed																																																																		
LMH hard paint laser marked																																																																		
LEGEND*																																																																		
	edge																																																																	
	136 ▲																																																																	
	center																																																																	
	118 OK																																																																	
	123 ⏻																																																																	
MODULE																																																																		
95	C	ACTUATION FORCE	LED*	COLOR	LEGEND TYPE*	LEGEND*		TYPE																																																										
MODULE	CAP	<table border="0" style="width: 100%;"> <tr> <td style="width: 50%;">35 3.5N</td> <td style="width: 50%;"></td> </tr> <tr> <td>65 6.5N</td> <td></td> </tr> </table>	35 3.5N		65 6.5N		<table border="0" style="width: 100%;"> <tr> <td style="width: 50%;">02 blue</td> <td style="width: 50%;"></td> </tr> <tr> <td>22 green</td> <td></td> </tr> <tr> <td>29 high intensity green</td> <td></td> </tr> <tr> <td>42 yellow</td> <td></td> </tr> <tr> <td>61 white</td> <td></td> </tr> <tr> <td>82 red</td> <td></td> </tr> </table>	02 blue		22 green		29 high intensity green		42 yellow		61 white		82 red		<table border="0" style="width: 100%;"> <tr> <td style="width: 50%;">16 frosted white</td> <td style="width: 50%;"></td> </tr> <tr> <td>09 black</td> <td></td> </tr> </table>	16 frosted white		09 black		<table border="0" style="width: 100%;"> <tr> <td style="width: 50%;">Blank pad printed</td> <td style="width: 50%;"></td> </tr> <tr> <td>LMH hard paint laser marked</td> <td></td> </tr> </table>	Blank pad printed		LMH hard paint laser marked		<table border="0" style="width: 100%;"> <tr> <td colspan="2" style="text-align: center;">LEGEND*</td> </tr> <tr> <td style="width: 50%;"></td> <td style="width: 50%; text-align: center;">edge</td> </tr> <tr> <td></td> <td style="text-align: center;">136 ▲</td> </tr> <tr> <td></td> <td style="text-align: center;">center</td> </tr> <tr> <td></td> <td style="text-align: center;">118 OK</td> </tr> <tr> <td></td> <td style="text-align: center;">123 ⏻</td> </tr> </table>		LEGEND*			edge		136 ▲		center		118 OK		123 ⏻	<table border="0" style="width: 100%;"> <tr> <td style="width: 50%;">C controlmec 1ZW</td> <td style="width: 50%;"></td> </tr> <tr> <td>C nonilluminated</td> <td></td> </tr> <tr> <td>D illuminated</td> <td></td> </tr> </table>	C controlmec 1ZW		C nonilluminated		D illuminated																	
35 3.5N																																																																		
65 6.5N																																																																		
02 blue																																																																		
22 green																																																																		
29 high intensity green																																																																		
42 yellow																																																																		
61 white																																																																		
82 red																																																																		
16 frosted white																																																																		
09 black																																																																		
Blank pad printed																																																																		
LMH hard paint laser marked																																																																		
LEGEND*																																																																		
	edge																																																																	
	136 ▲																																																																	
	center																																																																	
	118 OK																																																																	
	123 ⏻																																																																	
C controlmec 1ZW																																																																		
C nonilluminated																																																																		
D illuminated																																																																		

*optional

NOTICE : please note that not all combinations of above numbers are available. Contact APEM for further information.



MOUNTING

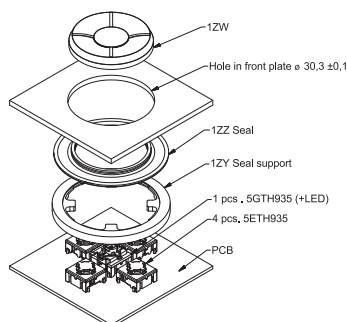

MATERIALS

- Cap :
 - solid color : ABS UL94HB
 - illuminated : polycarbonate UL94HB

Legends

Available for Multimec caps



STANDARD LEGENDS

STANDARD LEGENDS										
LEGEND	1DS09_	1FS096R_	1ZB09D_ 1ZB16DLMH_	1ZCS_	1Z_ 1ZW_	10A_	10C_	10D_	10Q_ 10QM16_	10R_ & 10RF_ 10RM16_
0	000	000								
1	001	001								
2	002	002								
3	003	003								
4	004	004								
5	005	005								
6	006	006								
7	007	007								
8	008	008								
9	009	009								
#	107	107								
*	019	019								
←	033									
→	133									
↑	034									
↓	134									
↙	135	135								
+						054			054	054
-						059			059	059
▲			136		136	136				
⏻	123	123		123*	123		123	123	123	123
ON/OFF									017	017
STOP									018	018
START									031	031
RESET				038					038	038
CANCEL									048	048
ENTER									105	105
ESC				051						
ON						116				
OFF						117				
OK				118*	118		118	118	118	118
SET				119						
MENU				120						
FUNC				121						
HOME				122						

STANDARD OPTIONS

- 1DS: pad printed
- 1FS: reverse printed
- 1ZB: pad printed / laser marked
- 1ZCS: pad printed / *reverse printed / *laser marked
- 1Z & 1ZW: pad printed / laser marked
- 10A: pad printed / laser marked
- 10C: pad printed / laser marked
- 10D: UV printed / laser marked
- 10R(F) & 10Q: pad printed / reverse printed
- 10RM & 10QM: metal symbol



HOW TO ORDER

POSITIONING OF LEGENDS ON ROCKER-ACTION CAPS

When ordering legends for caps with hinge-type cap retention system, it is important to note the position of the cap. An extra letter (U, D, R or L) needs to be added to the part number to refer to the position of the hinges in relation to the legend. See samples:

Rocker-action caps without a lens: 1A, 1B, 1M, 1ZA and 1ZB

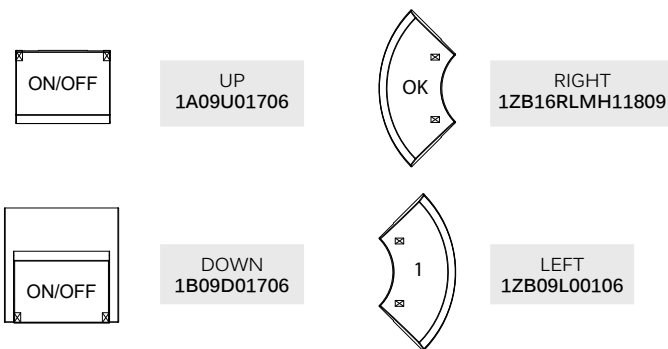

LEGEND ILLUMINATION

- **Option 1 - laser marked:** In case of laser marked legends an "LM" is added after the cap colour, before the legend code. We recommend using hard paint (additional "H") for increased lifetime of the paint. E.g. 1ZB16DLMH13609
- **Option 2 - reverse printed:** In case of reverse printed caps an "R" is added after the cap colour, before the legend code. Especially relevant when standard legends have both negative and positive print options. E.g. 1FS096R00009
- **Option 3 - metal symbol:** Only available for 10RM and 10QM (therefore the "M"). E.g. 10RM16059

ORIENTATION OF THE SWITCH

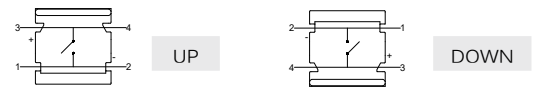

STANDARD AND CUSTOM LEGENDS

- Standard are only certain legends on certain caps. See the table on the previous page.
- All standard pad-printed legends are white on black caps.
- All standard reverse-printed and laser marked legends are black on frosted white cap.

STANDARD LEGENDS

CAP	CAP COLOR	DIRECTION*	TYPE*	LEGEND	LEGEND COLOR*	
1DS	00 Blue	D Down	UV UV printed	001 1	00 Blue	
1FS	02 Green	U Up	LM Laser marked on soft paint	002 2	02 Green	
...	03 Grey	R Right	LMH Laser marked on hard paint	003 3	03 Grey	
	04 Yellow	L Left	R Reverse printed	... etc	04 Yellow	
	06 White	*Only for hinge-type caps			06 White	
	08 Red		*In case of illumination		08 Red	
	09 Black				09 Black	
	16 Frosted white				... Etc	
	... Etc				*In case of reverse printed and laser marked legends the colour of the paint	

























Notice: The size of the legends listed may not correspond to the actual size.

If you decide to use one of the standard legends without any adjustments (without a new cliché or programming) on another cap than designated in the table, then there is no cliché or programming cost, for this to apply the cap has to be black and the print white.

For further information on legends please contact your local distributor or MEC.

Solid colors

Available for Multimec™ caps

		Colour / RAL Code																		
		Blue / 5012	green / 6018	Grey / 7004	Yellow / 1023	White / 9010	Red / 3000	Black / 9004	Ultra blue / 5002	Mint green / 6029	Tele grey / 7046	Melon / 1028	Signal white / 9003	Noble red / 3002	Dusty blue / 5014	Aqua blue / 5021	Metal dark blue / No ral code	Metal light grey / No ral code	Metal dark grey / No ral code	Metal bordeaux / No ral code
CAP	CODE	00	02	03	04	06	08	09	30	32	33	34	36	38	40	42	50	53	57	58
1A		•	•	•	•	•	•	•												
1B		•	•	•	•	•	•	•												
1DS		•	•	•	•	•	•	•	•	•	•	•		•	•	•	•	•	•	•
1ES/1FS				•			•	•												
1GAS/1GCS		•	•	•	•	•	•	•												
1H				•				•												
1JS		•	•	•	•	•	•	•												
1KS		•	•	•	•	•	•	•												
1LS								•												
1M			•	•			•	•												
1NS				•				•												
1PS		•	•	•	•	•	•	•												
1QS		•		•				•												
1RS				•																
1SS		•	•	•	•	•	•	•												
1TS/1US/1VS		•		•			•	•												
1WAS/1WDS/1WPS				•				•												
1XS				•		•		•												
1ZA				•		•		•	•						•	•	•	•	•	•
1ZB				•		•		•	•						•	•	•	•	•	•
1ZCS				•		•	•	•	•						•	•	•	•	•	•
1Z/1ZW				•		•		•												
10A				•			•	•												
10C		•		•			•	•					•							
10D				•		•		•												
10R/10RF + 10Q		•	•	•	•	•	•	•												

The RAL Codes mentioned are the codes nearest to the solid colors in the multimec™ range.

Cap & Bezel Specifications

Multimec™ caps

ACCESSORY SPECIFICATIONS

MATERIAL	PARTS	TEMP. LIMIT	UL RATING
ABS	Solid color 1A, 1B, 1DS, 1ES, 1FS, 1H, 1JS, 1KS, 1LS, 1M, 1NS, 1PS, 1QS, 1RS, 1TS, 1US, 1VS, 1WAS, 1WDS, 1WPS, 1XS, 1Z, 1ZA, 1ZB, 1ZCS, 1ZW, 10A, 10C, 10Q, 10R, 10RF and AQCS Bezels 2C, 2D and 2K, reflectors for 1KBS, 1KCS, 1YS and 1YAS	Max 65 °C Max 149 °F	UL94HB
Polycarbonate	All lenses and transparent colour caps, lids for 1KBS & 1KCS	Max 85 °C Max 185 °F	UL94HB
Polyamide	1GAS, 1GCS, 1SS and 2SS	Max 160 °C Max 320 °F	UL94V2
Legends adhesion	DS/EN ISO 2409 Class 1 & ASTM D3359 Class 4B		

EXTENDERS



5 mm, 6 mm,
7 mm, 8 mm,
9 mm, 10 mm

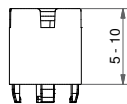

2SS

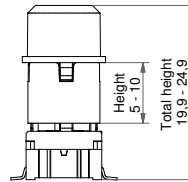

SMD + 2SS+1DS

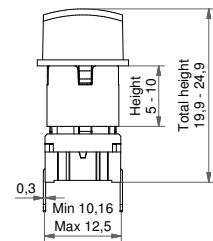

TH+2SS+1TS

HOW TO USE 1GAS/1GCS + 2SS UNDER FOIL

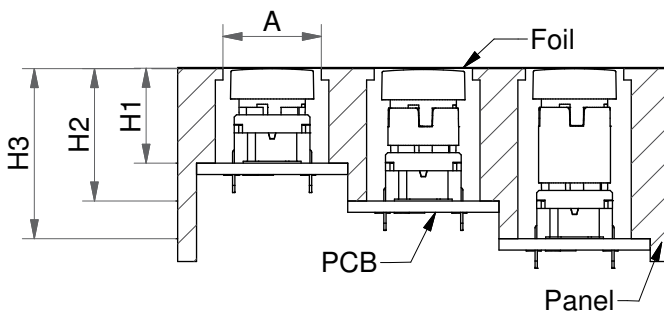

- A=We recommend space for travel of the foil and leave the area free from adhesive.
- H=We recommend you to calculate this dimension from the top of the PCB to the inner top of the panel.

2SS CAN BE USED WITH ALL 5G-TYPE SNAP-ON CAPS

All 2SS extenders are stackable giving the possibility to match most overall heights.

CAP SERIES	ORIGINAL HEIGHT (H1)	HEIGHT WITH A SINGLE EXTENDER (H2,H3)
1DS/1ES/1FS	14.9	19.9-24.9
1GAS/1GCS	12.5	17.5-22.5
1KS/1KBS/1KCS	19.1 ; 20.2 ; 20.1	24.1; 25.2; 25.1-29.1; 30.2; 30.1
1NS	14.9	19.9-24.9
1TS/1US/1VS	14.9	19.9-24.9
1WAS/1WDS/1WPS	15.7	20.7-25.7
1XS	18.5	23.5-28.5
1ZCS	11.7	16.7-21.7
10C	13.7	18.7-23.7
10D	12.0	17.0-22.0

Cap & Bezel Specifications

Multimec™ caps



HOW TO ORDER

EXTENDERS

SWITCH	MOUNTING	ACTUATION FORCE	LED (OPTIONAL)	CAP	EXTENDER 2SS HEIGHT
5G	TH9 Through-hole SH9 Surface mount	20 35 65	02 blue 22 green 42 yellow 61 white 82 red 2242 green/yellow 8222 red/green 8242 red/yellow	See the table on the previous page	05 06 07 08 09 10

Multimec™ 5

High performance tactile switches •
MIL-PRF-28855H • excellent illumination



DISTINCTIVE FEATURES

- Large range of accessories
- Momentary switches with NO or NC/NO function
- Sealed to IP67
- Single or bi-color illumination option
- Illumination with integrated chip-LEDs



ENVIRONMENTAL SPECIFICATIONS

- Sealing : IP67 according to IEC 60529
- Working and storage temperature :
 - non-illuminated : -40 °C/+160 °C (-40 °F to +320 °F)
 - illuminated : -30 °C/+85 °C (-22 °F to +185 °F)
- Soldering :
 - through-hole : IEC 60068-2-20 8
 - surface mount : JEDEC J-STD-020E



ELECTRICAL SPECIFICATIONS

- Recommended load :
 - Gold contacts : 0.5 μ-50 mA 24 VDC
 - Silver contacts : 0.5-50 mA 24 VDC
- Contact resistance : <30 mΩ - typically 10 mΩ
- Insulation resistance : >10 MΩ
- Contact bounce : <2 mS - typically 0.5 mS



MECHANICAL SPECIFICATIONS

- Standard actuation force :
 - momentary NO : 2.0 N, 3.5 N, 6.5 N
 - quiet version : 2.0 N
 - NC/NO function : 3.5 N
- Max. actuation force :
 - momentary : 115 N for 60 sec (according to MIL-PRF-22885H)
 - NC/NO : 100 N for 10 sec
- Travel : 1 mm
- Lifetime : >10,000,000 cycles

The company reserves the right to change specifications without notice.



MATERIALS

- Housing : PPS UL94V0
- Actuator : PPS UL94V0
- Sealing : Silicone rubber
- Contacts spring : Stainless steel
 - Silver : +3 μAg
 - Gold : +1 μAu
- Fixed contacts :
 - Silver : SnCu + 2μNI + 3μAg
 - Gold : SnCu + 2μNI + 1μAu
- Terminals : SnCu + 2μNI + 3μSn100

Multimec™ 5

High performance tactile switches • MIL-PRF-28855H • excellent illumination

5G NON-ILLUMINATED

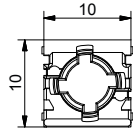

- SMD, TH or right angle TH
- NO or NC/NO

5G ILLUMINATED

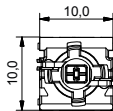

- SMD or TH
- NO
- single or bi-color LEDs

5E NON-ILLUMINATED

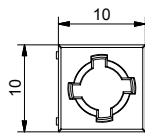

- SMD, TH or right angle TH
- NO or NC/NO

All tolerances unless otherwise noted : ±0.2 mm

PCB LAYOUT & CIRCUIT DIAGRAM

Non-illuminated

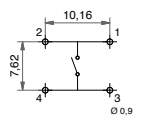

Single LED

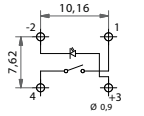

Bicolor - 2 LEDs

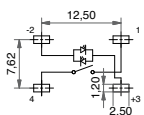
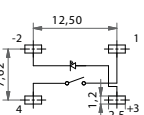
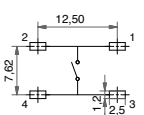
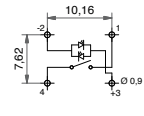

SMD

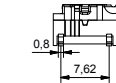
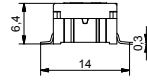

TH

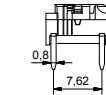
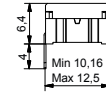

RAS

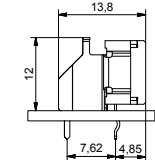
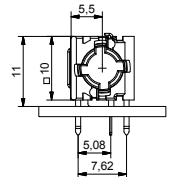

SMD

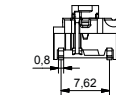
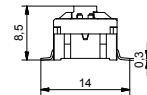

TH

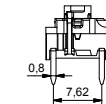
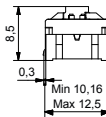

SMD

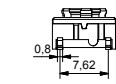
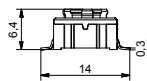

TH

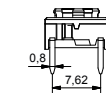
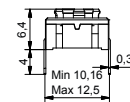

RAS

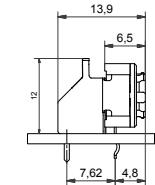
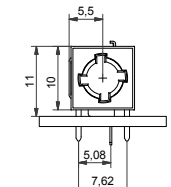

RAS

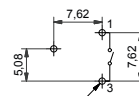

NC/NO function

*not for sale in Japan

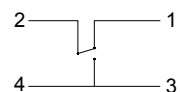

High performance tactile switches • MIL-PRF-28855H • excellent illumination



BUILD YOUR PART NUMBER

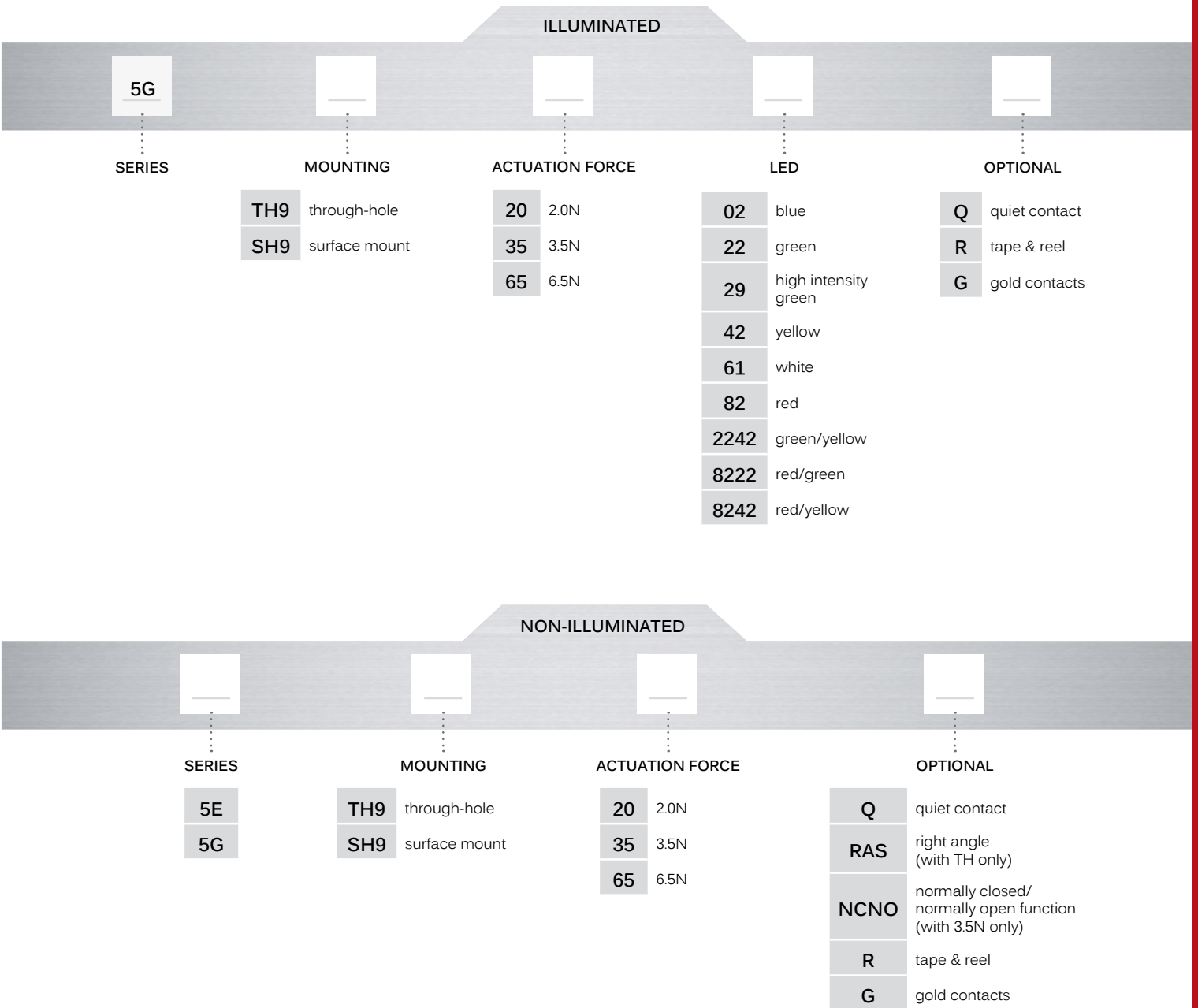

ABOUT THIS SERIES



Notice : please note that not all combinations of above numbers are available. Refer to www.apem.com for further information.

Multimec[®] 5

High performance tactile switches •
MIL-PRF-28855H • excellent illumination



TAPE & REEL

Tape and reel is available for the parts listed and has the following specifications

- Reel diameter: Ø330 mm
- Tape width: 24 mm
- Pitch: see list
- Tape and reel material: antistatic or better
- Quantity per reel: see list

PART NO.	ORDERING CODE	PITCH	QUANTITY PER REEL
5XSH9XX	5XSH9XXR	16	500
5XSH9XX1SSXX-08.0	5XSH9XXR1SSXX-08.0	20	250
5XSH9XX1SSXX-09.5	5XSH9XXR1SSXX-09.5	20	250
5XSH9XX1SSXX-10.4	5XSH9XXR1SSXX-10.4	20	250
5XSH9XX1SSXX-11.0	5XSH9XXR1SSXX-11.0	20	250
5XSH9XX1SSXX-12.0	5XSH9XXR1SSXX-12.0	20	250
5GSH9XX02	5GSH9XX02R	20	250
5GSH9XX22	5GSH9XX22R	20	250
5GSH9XX42	5GSH9XX42R	20	250
5GSH9XX61	5GSH9XX61R	20	250
5GSH9XX82	5GSH9XX82R	20	250
5GSH9XX2242	5GSH9XX2242R	20	250
5GSH9XX8222	5GSH9XX8222R	20	250
5GSH9XX8242	5GSH9XX8242R	20	250



OPERATING FORCE

2.0 N

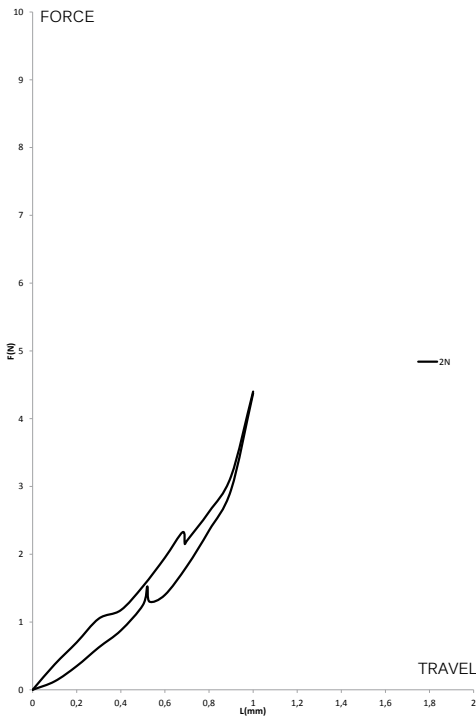

3.5 N

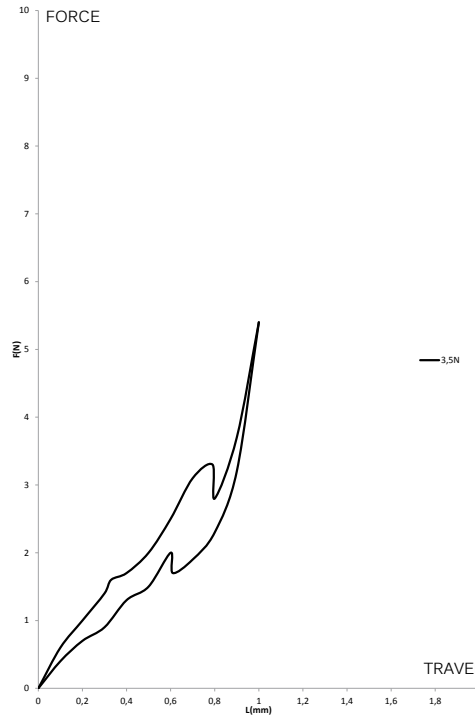

6.5 N

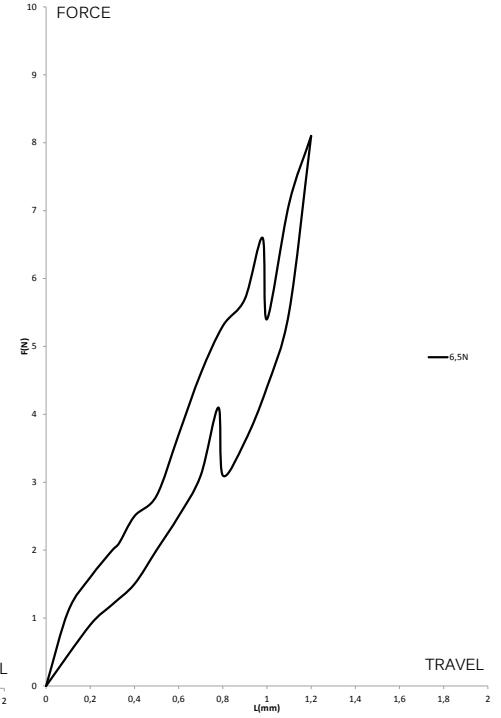

Multimec® 5

High performance tactile switches • MIL-PRF-28855H • excellent illumination



RECOMMENDED OPERATING CONDITIONS

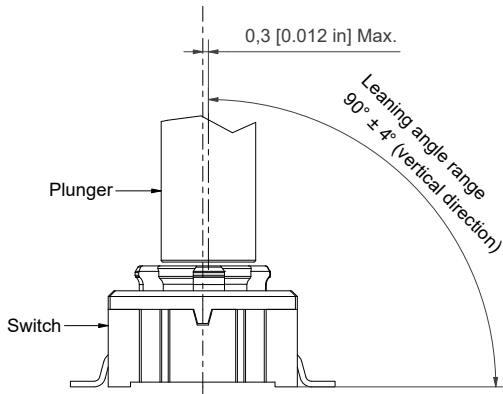

For the optimal performance of the switch use the recommended operating conditions.



MOUNTING

MOUNTING TOOLS FOR MULTIMEC® THROUGH-HOLE SWITCHES

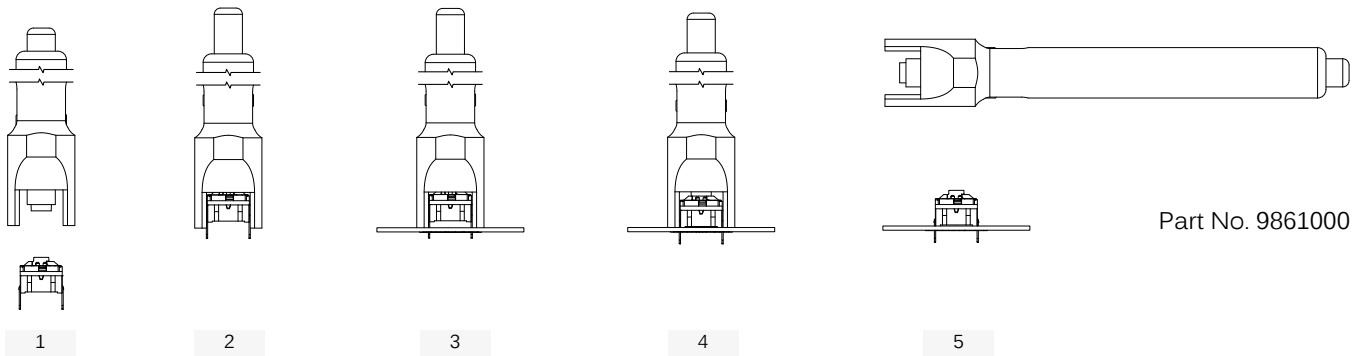

MULTIMEC® SPACING EXAMPLES

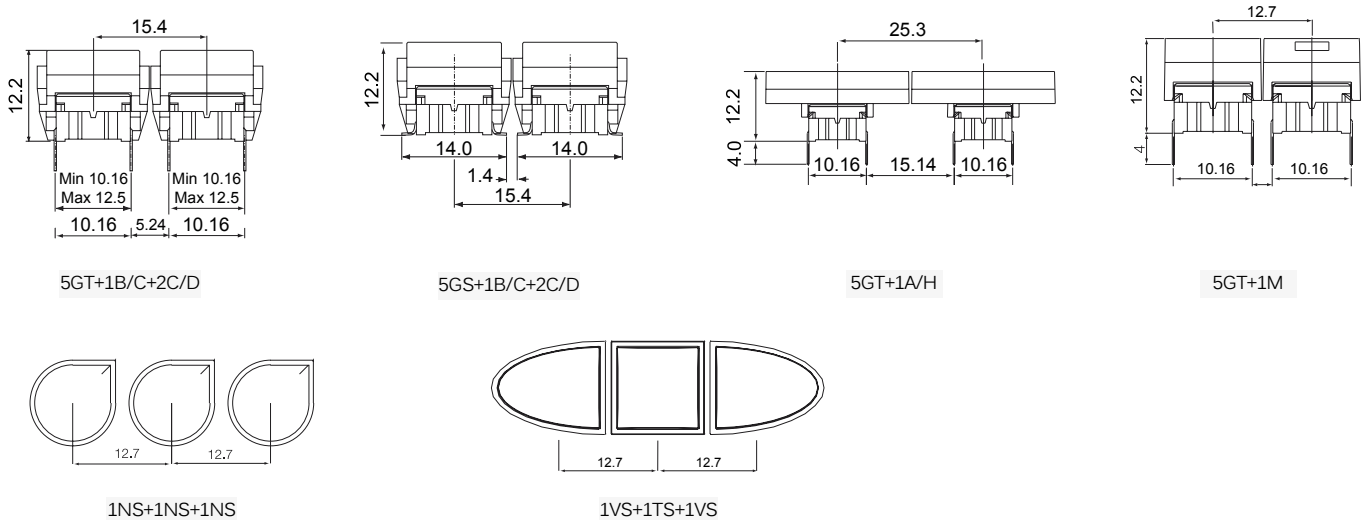

Multimec[®] 5

High performance tactile switches •
MIL-PRF-28855H • excellent illumination



MOUNTING (CONTINUED)

SPACE REQUIREMENT - MATRIX MOUNTING

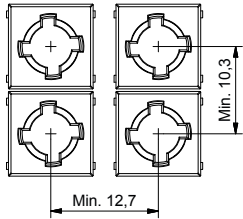

Through-hole (TH)

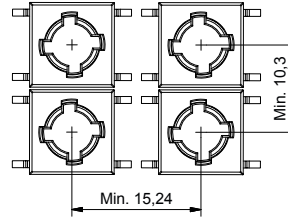

Surface mount (SMD)

SPACE REQUIREMENT - SWITCH/CAP

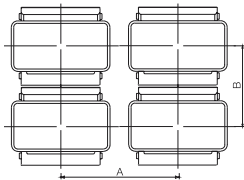

Switch spacing

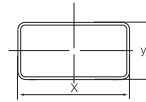

Cap dimensions

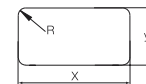

Panel cut-out

CAP SERIES	RECOMMENDED MIN. SWITCH SPACING AxB	NOMINAL CAP DIMENSION WxH	RECOMMENDED MIN. PANEL CUT-CUT
1A/1H	12.7x10.16	12.6x10.1	13.0x10.5
1B+2C/2D	15.24x15.24	15.1x15.1	15.5x15.5
1DS/1ES/1FS	12.7x12.7	Ø9.6	Ø10
1GAS	12.7x11.14	Ø11	Ø11.4
1GCS	15.14x15.14	Ø15	Ø15.4
1JS	12.7x12.7	Ø9.6	Ø10.4
1KS/1KBS/1KCS	15.24x15.24	14.3x14.3	14.7x14.7
1M	25.4x10.16	25x10	27.7x10.5
1NS	12.7x12.7	Ø9.8/ □4.9	Ø10.2/□5.1
1PS/ 1QS/1RS	15.24x10.16	6.5x12.5	7x13, R max. 1
1SS/1IS/1LS	12.7x12.7	Ø6.5	Ø7
1TS	12.7x12.7	10.6x10.6	11x11
1US	12.7x12.7	Ø10.6	Ø11
1VS	12.7x12.7	10.6x13.25	11.0x13.65
1WAS/1WPS	12.7x10.3	12.5x6.5	12.9x6.9
1WDS	15.34x10.3	15.2x8	15.6x8.4
1XS	12.7x12.7	9.4x7.4	9.8x7.9
1YS/1YAS	18.84x10.3	18.7x10.1	19.4x10.5
1ZA	17x17	15x15	16x16
1ZB	24.34x12.1	R1=7.4; R2=17.5 90°	R1=7.1; R2=17.5-17.75 90°
1ZCS	14.44x14.44	Ø14.3	Ø14.7
1Z/1ZW	35.5x35.5; 41.6x41.6	Ø29.5	Ø30.3
10A	17x35	R=5.3; 10.6x28	R=5.5; 11x28.4
10C	non-ill: 24 x 24; ill.: 30.2x30.2	Ø19.2	Ø19.8
10D (+10DWY)	19x19 (27x27)	Ø16	Ø16.4
10R/10RF/10RM	40.5x40.5	Ø30	Ø30.6
10Q/10QM	32.5x32.5	22x22	22.5x22.5



LED COMPONENT SPECIFICATIONS

LED COMPONENT SPECIFICATIONS							
Color		Blue	Green	Yellow	White	Red	High Intensity Green
Color Codes		02	22	42	61	82	29
ABSOLUTE MAXIMUM RATINGS (Ta= 25°C)							
Power	mW	110	75	60	48	65	102.5
Current forward	mA	25	30	25	15	25	25
Forward peak current	mA	100	80	60	100	100	150
Voltage reverse	V	5	5	5	NA	12	5
Operating temperature	°C	-40/+85	-55/+85	-40/+85	-40/+85	-30/+85	-40/+85
Storage temperature	°C	-40/+90	-55/+85	-40/+90	-40/+85	-40/+85	-40/+85
Soldering temperature	°C	245 for max 10 sec					
ELECTRICAL-OPTICAL CHARACTERISTICS (Ta=25 °C)							
Voltage forward	Typ. V	3.3	2	1.75**	2.85	2	3.3
	Max. V	3.7	2.4	2.35	3.1	2.5	4.1
Current reverse (VR=5V)	Max. µA	50	100	10	NA	100	50
Wave length	nm	470	571	591	NA	633	525
Spread	Δnm	25	NA	15	NA	16	30
Spread angle	degree	120	130	120	150	160	60
Luminous Intensity	Min. mcd	45	18	28.5	71	28	500
	Typ. mcd	122*	35	72*	224*	180*	1000
Optical intensity	Lm/w	NA	NA	NA	36	7	NA

*F=20 mA, **Pulse width 1ms Duty cycle 1:5, ***F=50 mA, ****Luminous Flux mlm

Multimec® 5

High performance tactile switches • MIL-PRF-28855H • excellent illumination



USAGE GUIDELINES

HOW TO GET THE BEST RESULTS WITH MEC SWITCHES ?

These guidelines are offered to users of MEC Switches as an aid to ensure successful and reliable switch operation. Please see the technical specifications for details on operating and storage temperatures and soldering guidelines to make sure you select the best switch for your application. When wave soldering is taking place, MEC strongly recommend that the temperature profile is analyzed and compared with the temperature rating of the switch. It is also important to monitor the accumulated heat buildup from both the pre-heat zones and the solder zone.

Most standard accessories for multimec® 5 series switches are made from ABS plastic with a maximum operating temperature of 65 °C. It is strongly recommended that accessories are mounted after soldering of the switch. If this is not possible care must be taken not to overheat the accessories during the soldering process. The 1SS and 1GAS/1GCS caps are, however, made of high temperature materials and will meet the same temperature specifications as the switches. For accessories made from other plastic materials please see multimec® 5 series technical specifications.

LEDs have their own temperature specifications. When fitted in a switch the LED will determine the max. operating temperature, i.e. 5GTH93522 has an upper temperature limit of 85 °C!

MOUNTING AND DISMOUNTING

If switches are to be mounted in rows it is essential that the recommendations regarding spacing are followed. PC board thickness should be 1.4 ±0.2 mm and terminal hole diameter should be 0.9 mm.

All multimec® 5 series caps and bezels are easily snapped onto the switch modules and can be changed at a later time.

A mounting tool is available for through hole multimec® 5 series switches.

SOLDERING AND CLEANING MULTIMEC® SERIES

Multimec® 5 series switches are fully sealed to IP67 specifications to minimize solder flux and aqueous based cleaning solutions from entering the switch and contaminating the contacts. The switches can be placed on the PC board with other components and wave soldered. Multimec® 5 series offers a high level of sealing, however, with aqueous solvent solutions care must be taken to avoid the worst

case situation with water jets, complete immersion into a liquid with a temperature below the board or surface tension reducing additives.

Recommended cleaning methods are demineralized water. Any surface tension reducing agents, such as soap, must not be used as they risk causing a potential leakage of the switch.

SOLDERING - THROUGH HOLE VERSIONS

Hand soldering: max. 350 °C for max. 3 sec

Wave soldering: heat built up in the switch during pre-heating and soldering must not exceed the maximum operating temperature of the switch. Peak temperature must not exceed 260 °C, and soldering time is max 10 sec. (IEC 60068-2-20 8)

SOLDERING - SURFACE MOUNT VERSIONS

For all methods - infrared, convection and vapor phase. The upper limit 240 °C/40 sec must be observed. The soldering temperature profile must have moderate temperature gradients. (JEDEC J-STD-020E)

ROHS COMPLIANCE

As of 1 July 2006 MEC has completed the conversion to RoHS compliance. For more info please see our homepage www.apem.com

TEMPERATURE LIMITS:

Switch	160 °C
LEDs	85/90 °C
Accessories	65/85/160 °C

PACKAGING

Multimec® 5 series switches are packed in rigid tubes of 50 pieces each.

A box contains 1.000 pcs.

The surface mount versions of multimec® 5 series switches with a height up to 12.5 mm can also be delivered on tape/reel.

Each reel contains 250/500 pcs.